



COMANSA

LINDEN 2100

21 LC 290

18 t

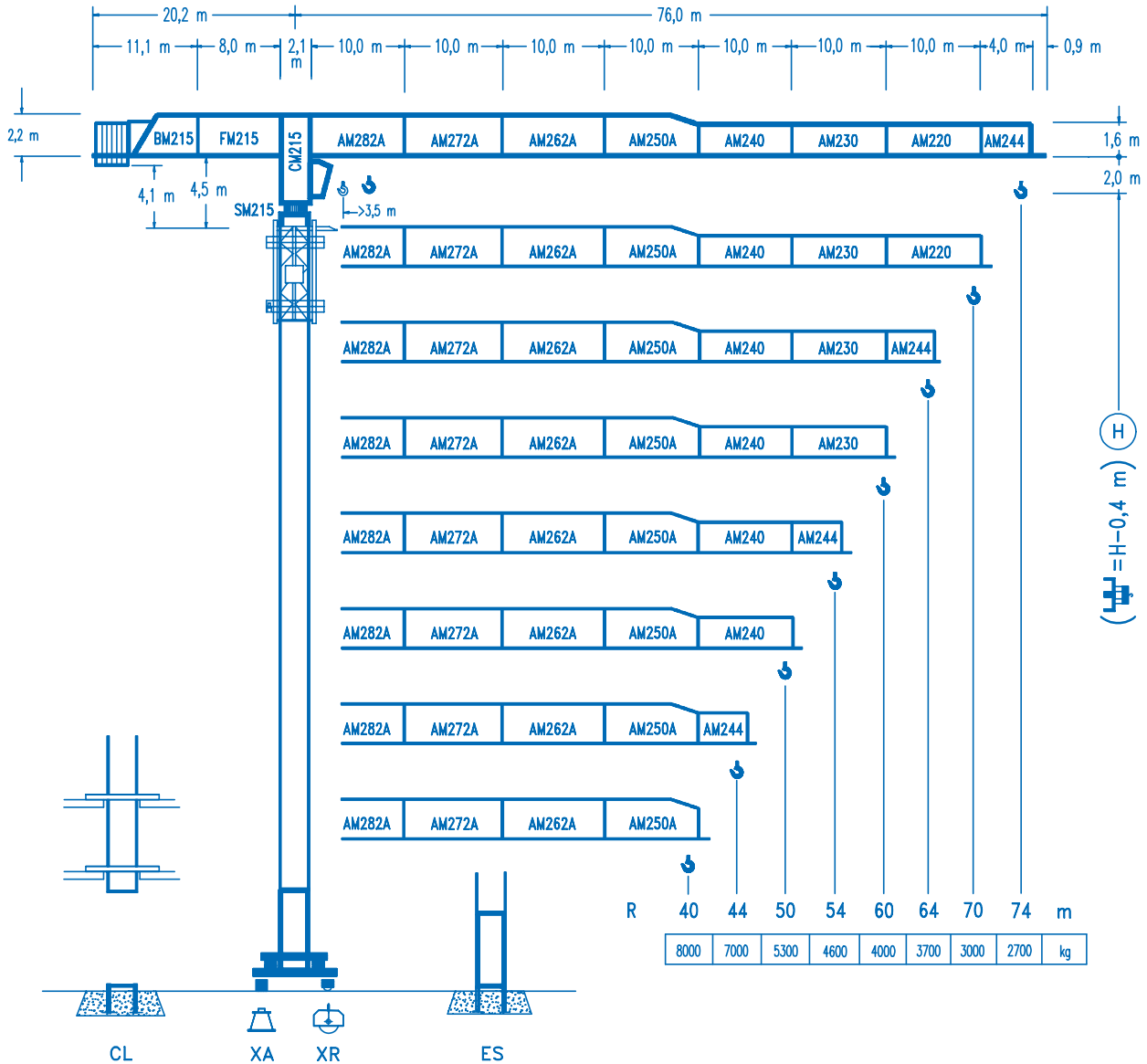

(H) = H - 0,4 m

CE
DIN 15018 H1 B3

R	[Symbol]				[Symbol]											
74	14,3	15	20	25,8	25,9	30	34	40	44	50	54	60	64	70	74	m
	18000	17005	12165	9000	9000	7660	6660	5545	4980	4300	3930	3475	3220	2890	2700	kg
70	14,6	15	20	26,4	26,7	30	34	40	44	50	54	60	64	70	m	
	18000	17460	12500	9000	9000	7920	6890	5745	5155	4455	4075	3605	3340	3000	kg	
64	15,7	20	25	28,4	29,1	34	40	44	50	54	60	64	m			
	18000	13585	10470	9000	9000	7580	6325	5685	4920	4505	3990	3700	kg			
60	15,6	20	25	28,2	29,1	34	40	44	50	54	60	m				
	18000	13480	10390	9000	9000	7585	6335	5695	4930	4515	4000	kg				
54	15,7	20	25	28,5	29,6	34	40	44	50	54	m					
	18000	13610	10500	9000	9000	7725	6450	5800	5020	4600	kg					
50	16,3	20	25	29,7	31,0	34	40	44	50	m						
	18000	14255	11010	9000	9000	8140	6800	6115	5300	kg						
44	18,2	20	25	30	33,1	35,0	40	44	m							
	18000	16115	12480	10100	9000	9000	7775	7000	kg							
40	18,5	20	25	30	33,8	35,9	40	m								
	18000	16490	12775	10345	9000	9000	8000	kg								

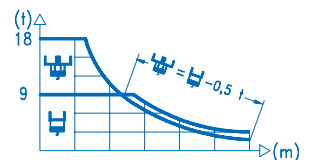

DS.0346.28

09/05

Reserva de modificaciones.- Subject to modifications.- Modifications réservées.- Konstruktionsänderungen vorbehalten.

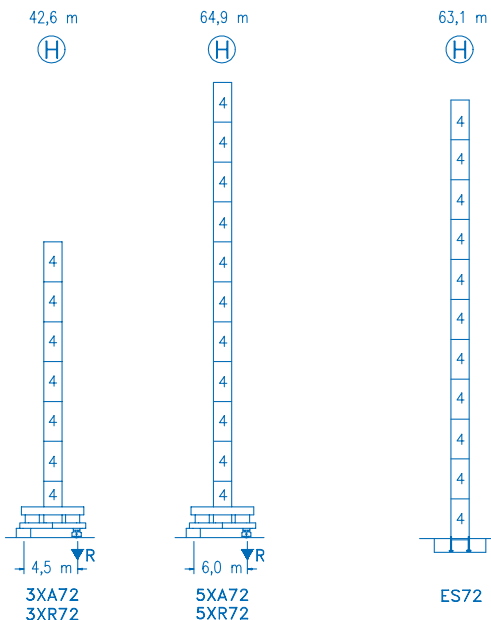

N	Ref.	h (m)
3	TD23A	2,0 5,5
4	S25	2,0 5,5
11	CLD23A	2,0 3,1

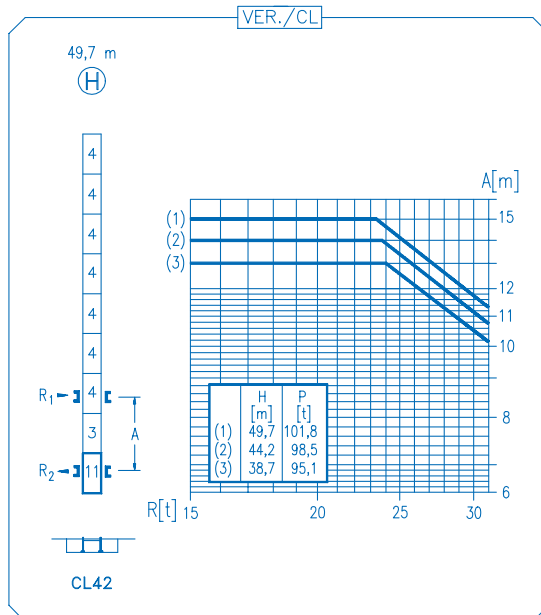

R. máx.	En servicio In operation En service In Betrieb	3XR72 105,9 t
		5XR72 113,6 t

R. máx.	Fuera de servicio Out of service Hors service Ausser Betrieb	3XR72 90,3 t
		5XR72 150,3 t

CFU-7.5
7,5 kW
0 ↻ 94 m/min

GR-12
3 x 120 Nm
0 ↻ 0,7 rpm

TRA-7.5
2 x 75 Nm
0 ↻ 20 m/min

TRA-7.5VC
2 x 75 Nm
0 ↻ 20 m/min
5XR72

EFU4-45-45
545 m
45 kW
0 ↻ 94 m/min

EFU4-65-45
620 m
65 kW
0 ↻ 94 m/min

EFU4-110-45
790 m
110 kW
0 ↻ 94 m/min

Tensión de alimentación Operating voltage Tension de service Betriebsspannung	400 V 3 ph 50 Hz
--	---

Opcional Optional En option Kaufoption	*
---	---































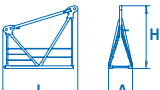





LINDEN 2100

Designación Designation Designation Benennung	Código Code Code Code	Dimensiones / Measurements Dimensions / Abmessungen [m]			Peso Weight Poids Gewicht [kg]
		L	A	H	
Pie de empotramiento Fixing angles Pattes de scellement Fundamentanker	PS4	1,98	0,40	0,40	(4x) 190
	PS5	1,98	0,40	0,40	(4x) 220
	PD3-2	2,10	0,48	0,48	(4x) 275
	PD4-2	2,10	0,48	0,48	(4x) 325
Base en cruz Cross-base Base en croix Kreuzrahmen	X3	6,55	1,00	1,55	6400
	acc. trasl.	6,55	1,00	1,55	8000
	X5	9,00	1,80	2,00	11000
	acc. trasl.	9,00	1,80	2,00	17000
Base en "H" "H"-base Base en "H" Unterwagen	"H"	10,32	1,72	1,43	(2x) 3950
	Testera	11,61	1,28	1,05	(2x) 5250
	Puntal	8,05	0,51	0,42	(4x) 1850
	Diagonal	4,70	0,34	0,42	(4x) 710
	Oreja	0,85	0,36	0,51	(4x) 165
	Trasl. M.	1,70	0,68	1,44	(2x) 1350
	Trasl. L.	1,70	0,48	1,44	(2x) 1050
Lastre Base ballast Lest de base Ballast	5400 kg	4,50	1,00	0,50	5400
	6750 kg	6,25	1,50	0,60	6750
	5620 kg	6,51	0,60	0,60	5620
Tramo de torre Mast section Element de tour Turmmodul	S22	5,75	2,10	2,10	2175
	S23	5,75	2,10	2,10	2560
	TS24	5,75	2,10	2,10	2950
	S24	5,75	2,10	2,10	2950
	TS25	5,75	2,10	2,10	3325
	S25	5,75	2,10	2,10	3325
	TD23A	5,75	2,10	2,10	4125
	D23	5,85	2,10	2,10	4175
	S35	5,75	2,60	2,60	3700
	TD33A	5,75	2,60	2,60	4320
	D33	5,85	2,60	2,60	4400
	TD34	5,85	2,60	2,60	5000
	D34	5,85	2,60	2,60	5000
	BD34	7,63	2,60	2,60	7300
	Parte giratoria Slewing part Partie giratoire Drehbare Bühne	SM212	2,46	2,32	2,40
SM215		2,46	2,35	2,50	6600
SM218/D23		2,46	2,35	2,50	7100
SM218/S35		3,05	3,05	3,15	8900
SM219		3,02	3,02	3,17	10900
Cúspide Cat head Tete de tour Turmspitze	CM212	5,45	1,60	2,47	2400
	CM215	5,47	1,60	2,50	3050
	CM218	6,70	1,60	2,50	4150
	CM219	6,70	1,60	2,56	5300
	plat. cab.	2,95	1,70	0,35	260
	cab.	1,75	1,40	2,30	550

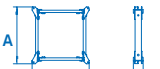

COMANSA

LINDEN 2100

Designación Designation Benennung	Código Code Code	Dimensiones / Measurements Dimensions / Abmessungen [m]			Peso Weight Poids Gewicht [kg]
		L	A	H	
Tramo de pluma Jib section Element de fleche Auslegermodul	 AM299	10,42	1,40	3,83	7100
	 AM298	10,40	1,40	3,70	5500
	 AM282A	10,35	1,40	2,48	4850
	 AM272A	10,30	1,40	2,43	4300
	 AM262A	10,27	1,40	2,41	3600
	 AM250A	10,25	1,40	2,38	2700
	 AM240	10,24	1,40	1,76	1710
	 AM244	4,17	1,40	1,74	300
	 AM230	10,22	1,40	1,74	1310
	 AM220	10,10	1,40	1,71	930
 AM210	10,18	1,40	1,71	600	
 JE211	0,81	1,40	0,61	95	
Carro Trolley Chariot Laufkatze	 TLC09	1,91	1,65	1,02	250
	 TALC18	1,11	1,65	1,30	120
	 TACJ	1,49	0,69	0,27	25
	 TACT	1,49	0,69	0,27	25
Gancho Hook Crochet Haken	 GA09.0	1,39	1,12	0,57	290
	 GA18.0	1,99	1,29	0,28	540
Tramo de contrapluma Counterjib section Element de contrefleche Gegenauslegermodul	 FM218	4,36	1,40	3,67	1880
	 FM215	8,36	1,73	2,47	3270
	 BM215	11,53	2,20	2,57	7500
	 EFU2-37-30	1,65	2,16	1,27	2300
	 EFU4-45-30	2,67	2,14	1,27	3400
	 EFU4-65-30	2,82	2,17	1,75	4800
	 EFU4-110-30	3,44	2,23	1,75	6000
	 EFU4-45-45	2,67	2,14	1,27	3400
 EFU4-65-45	2,67	2,16	1,73	4200	
 EFU4-110-45	3,44	2,23	1,75	6000	
Contrapeso Counterweight Contrepoids Gegengewicht Block	 4000 kg	2,32	2,45	0,40	4000
	 2000 kg	1,17	2,45	0,40	2000
	 1000 kg	0,72	2,45	0,40	1000
Tramo trepador Climbing section Element de telescopage Klettermodul	 J3	9,20	2,50	2,80	8000
	 J4	9,50	3,30	3,04	12000
Marco arriostamiento Tie frame Cadre Abspannrahmen	 MA02	2,79	2,79	0,45	950
	 MA05	3,10	3,10	0,60	1500